



## Folding laundry roll containers

### Technical Features

Product code : RC2\_19 L730 x W830 x H1900mm

- Electro-galvanized
- Reinforced wire 4mm thick
- Wire mesh 50mm x 50mm
- No roof
- Optional shelf
- Double door type - opening to the side
- 2 fixed castors & 2 swivel with brakes
- Ø125mm diameter

Load capacity : 600kg  
Weight : 40kg

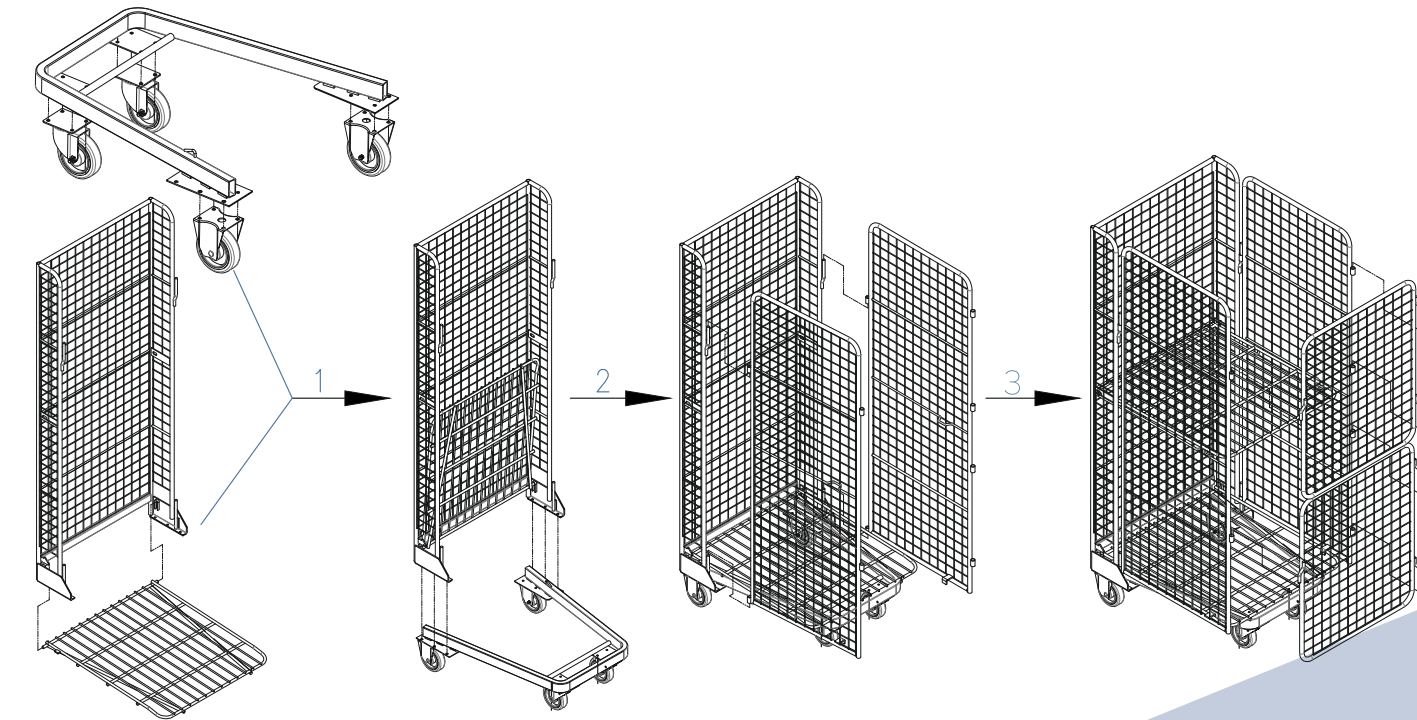
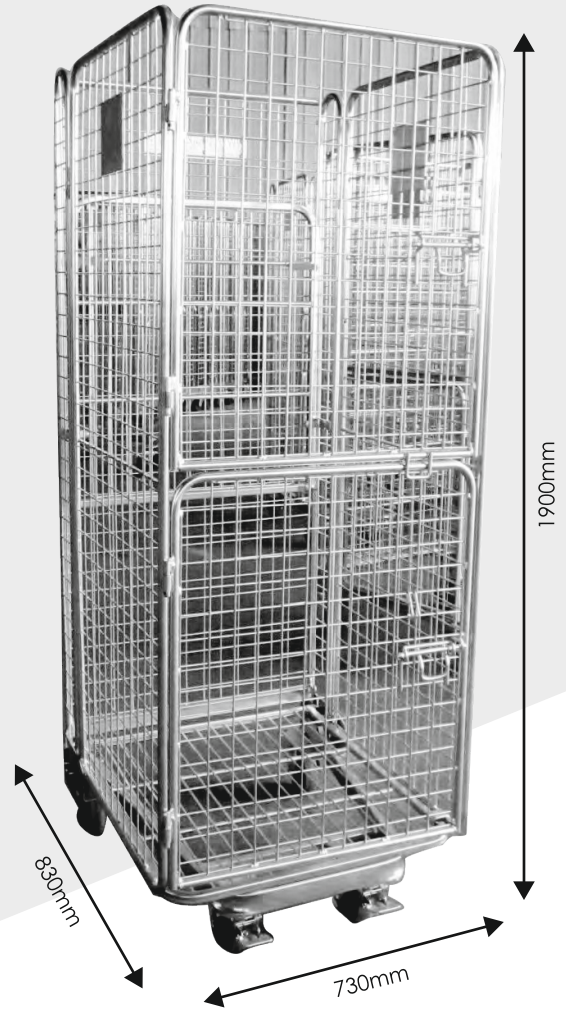

CUSTOMISE YOUR TROLLEYS WITH US



CUSTOMISE YOUR TROLLEYS WITH US

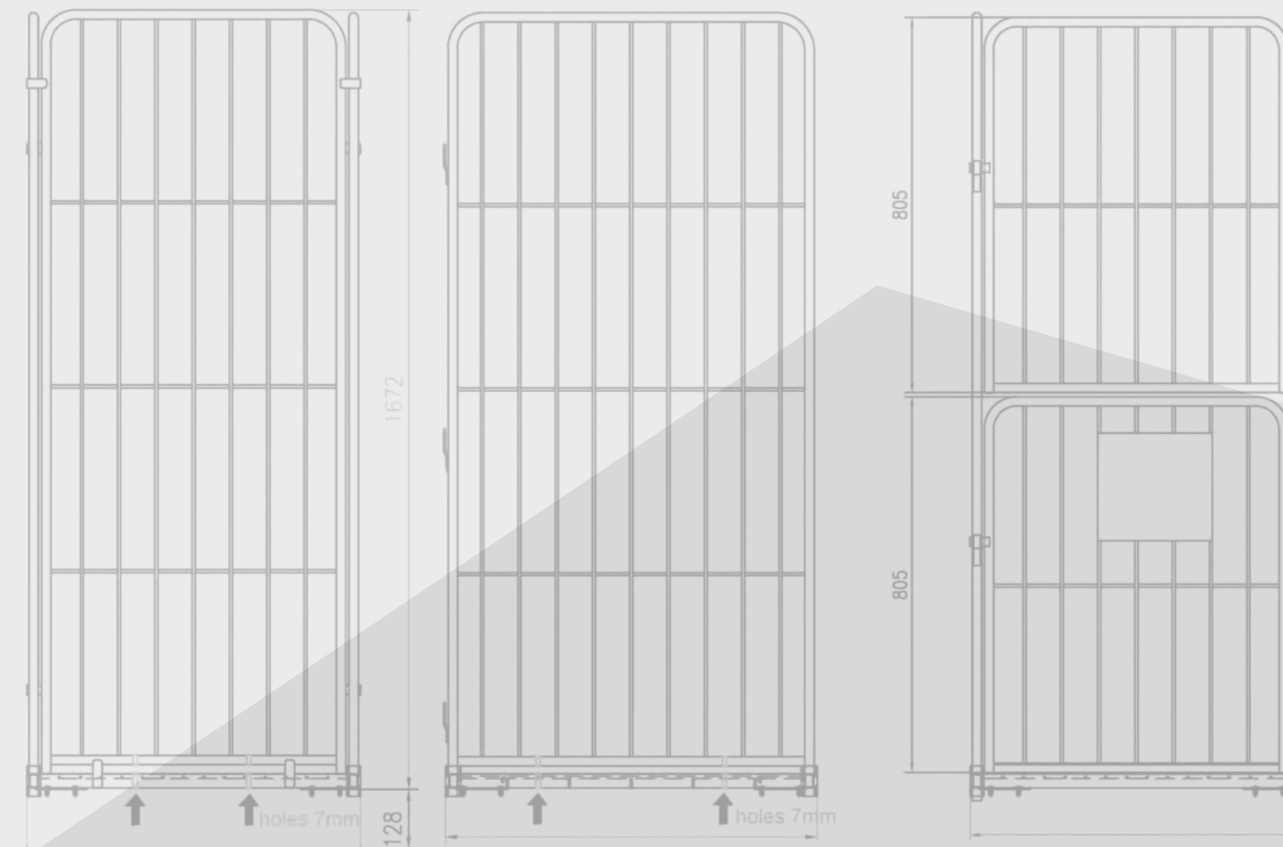

ELVEP  
info@elvep.gr  
www.elvep.com  
+302310792165

ELVEP  
Greece, 57300, 1st km Chalastra-Sindos  
Tel: +302310792165  
Email: info@elvep.gr  
Website: www.elvep.com



## Standard laundry roll containers

- Electro-galvanized
- Reinforced wire 6mm thick
- Wire mesh 75mm x 375mm
- No roof
- Double door type - opening to the side
- 2 fixed castors & 2 swivel with brakes
- Ø125mm diameter

Load capacity : 600kg  
Weight : 40kg

### Technical Features

Product code : RC1\_16 L715 x W800 x H1600mm

Product code : RC1\_18 L715 x W800 x H1800mm

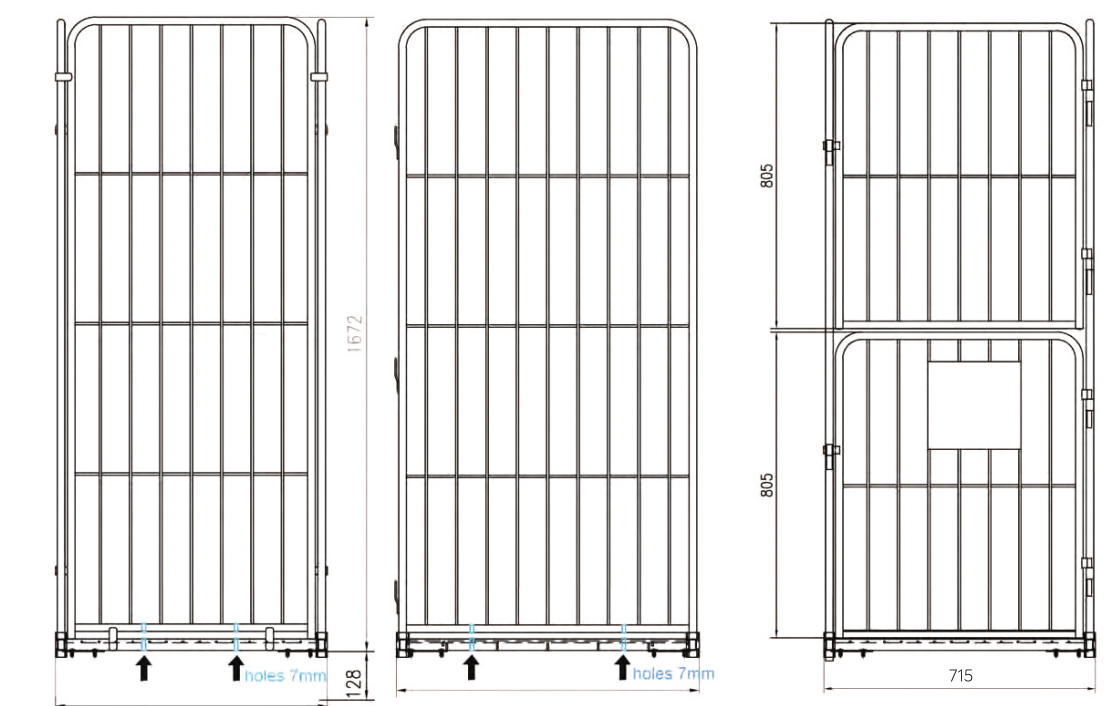

Holes 7mm on the base - 2 on each side - for further stability



## Narrow laundry roll containers

### Technical Features

Product code : RC3\_18 L600 x W1000 x H1800mm

Electro-galvanized  
Reinforced wire 5,8mm thick  
Wire mesh 50mm x 100mm  
No roof  
Optional shelf

Folding down double door type  
2 fixed castors & 2 swivel with brakes  
Ø125mm diameter

Load capacity : 600kg  
Weight : 45kg

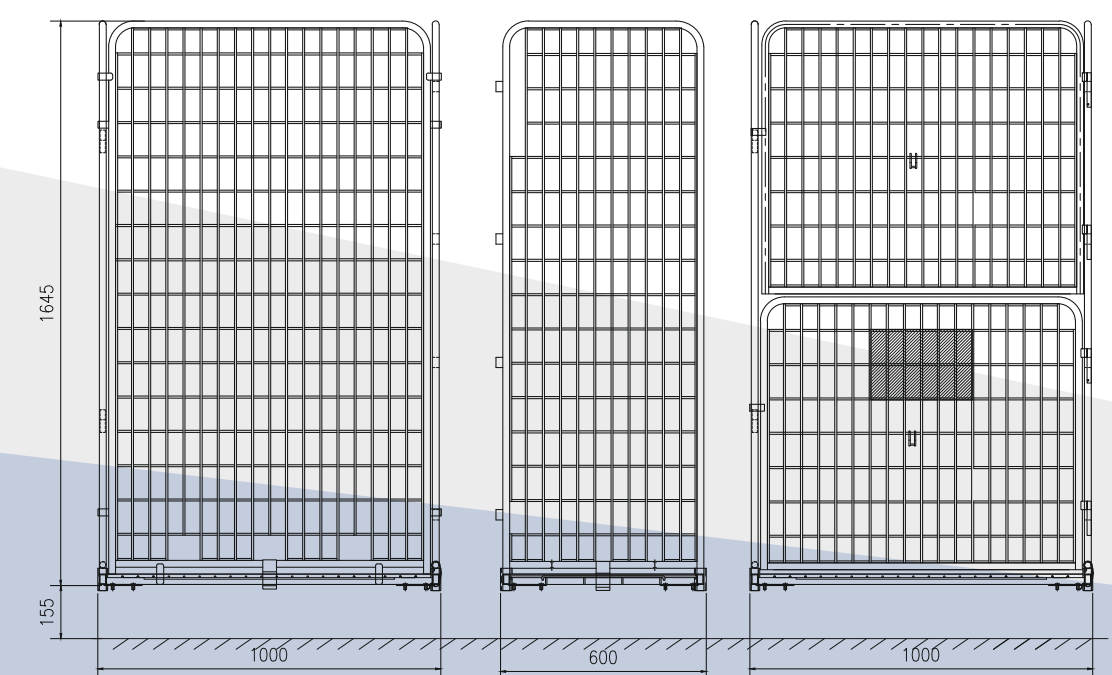
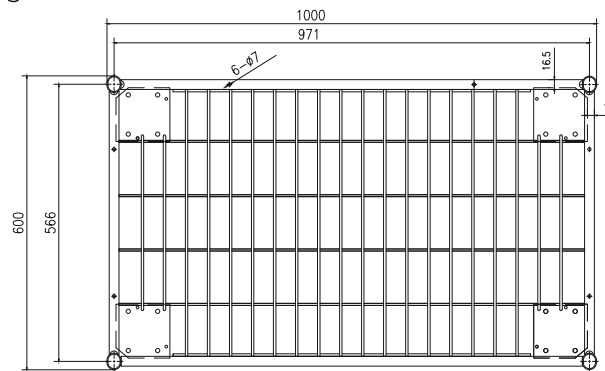

## Wide laundry roll containers

### Technical Features

Product code : RC4\_18 L800 x W1000 x H1800mm

Electro-galvanized  
Reinforced wire 6mm thick  
Wire mesh 75mm x 375mm  
No roof  
Double door type - opening to the side  
2 fixed castors & 2 swivel with brakes  
Ø125mm diameter

Load capacity : 600kg  
Weight : 40kg

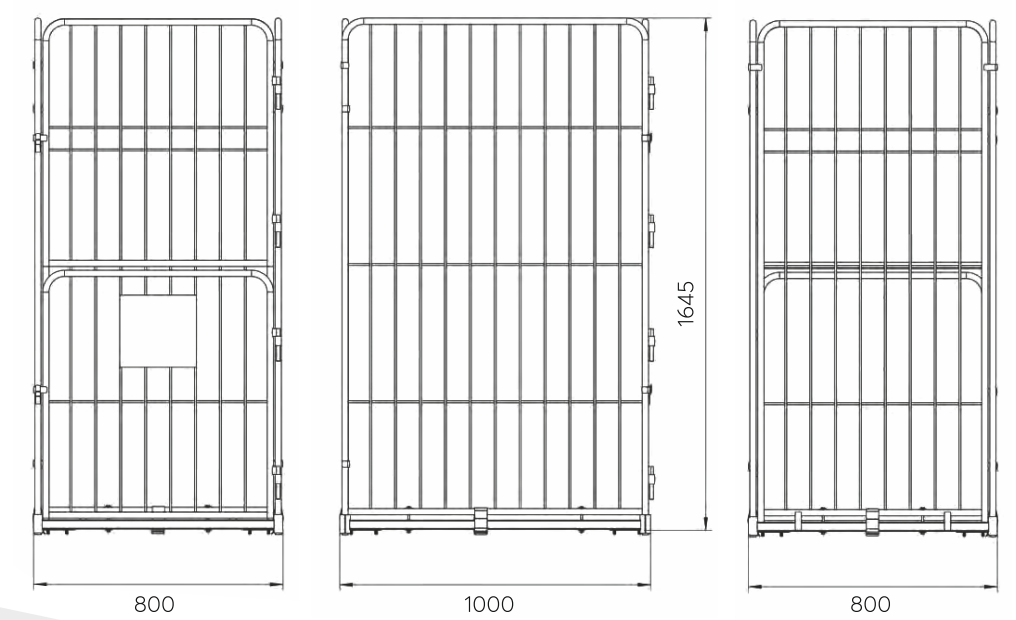
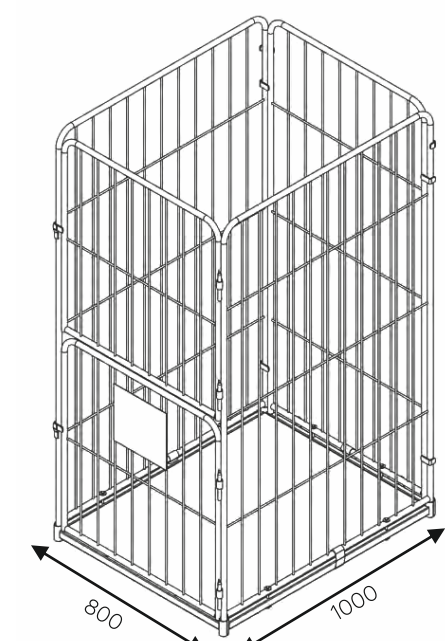
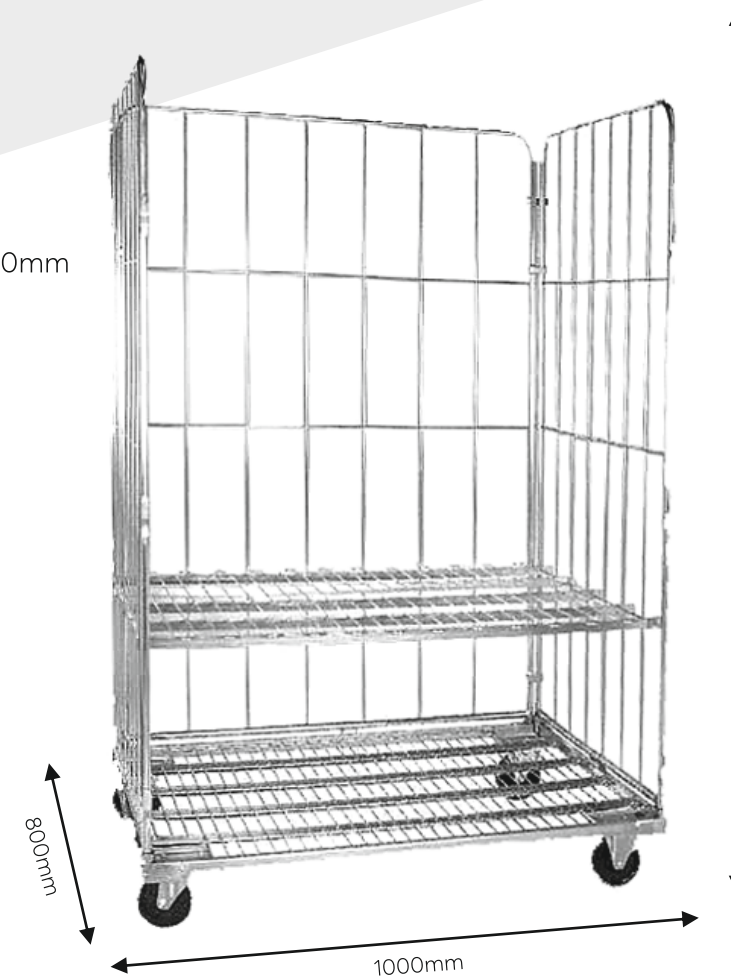

## Customized roll containers

### Technical Features

Product code : RC5\_18 L800 x W1200 x H1850mm

Electro-galvanized | Reinforced wire 5mm thick | Wire mesh 50mm x 100mm | Optional shelf  
Folding down double door type | 2 fixed castors & 2 swivel with brakes | Ø125mm diameter  
Load capacity : 600kg | Weight : 45kg

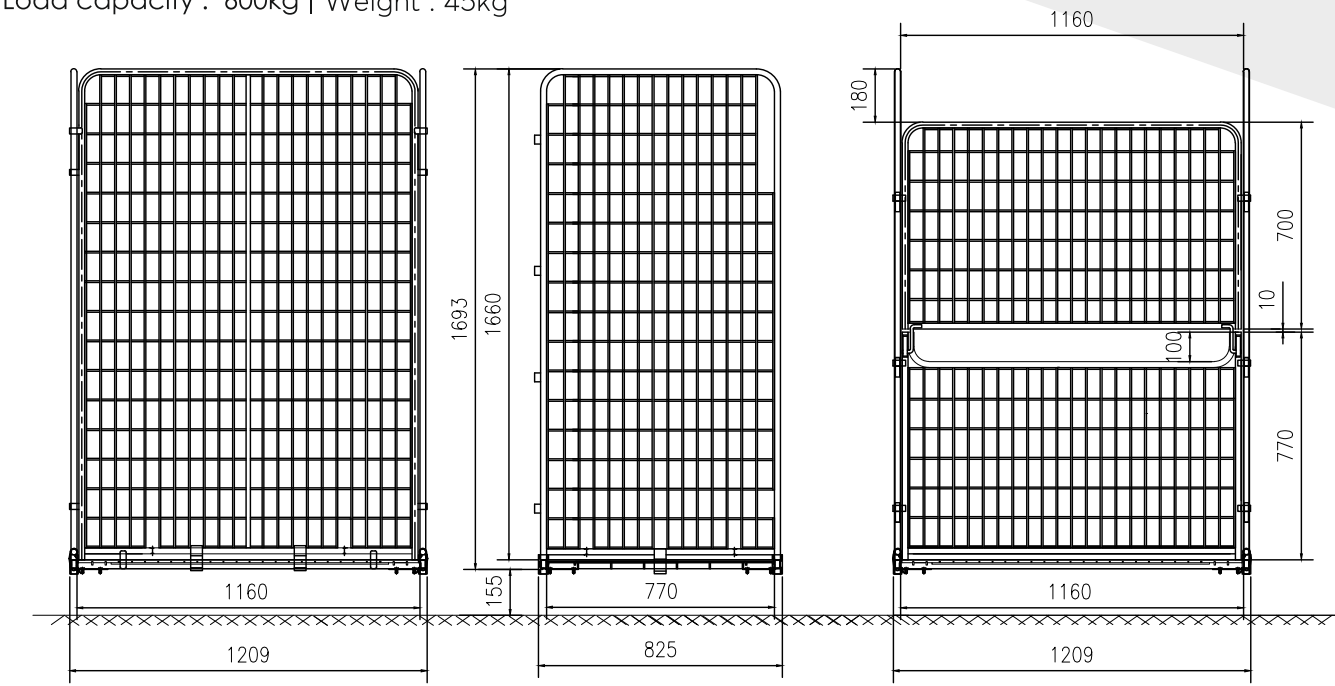

CUSTOMISE YOUR TROLLEYS WITH US

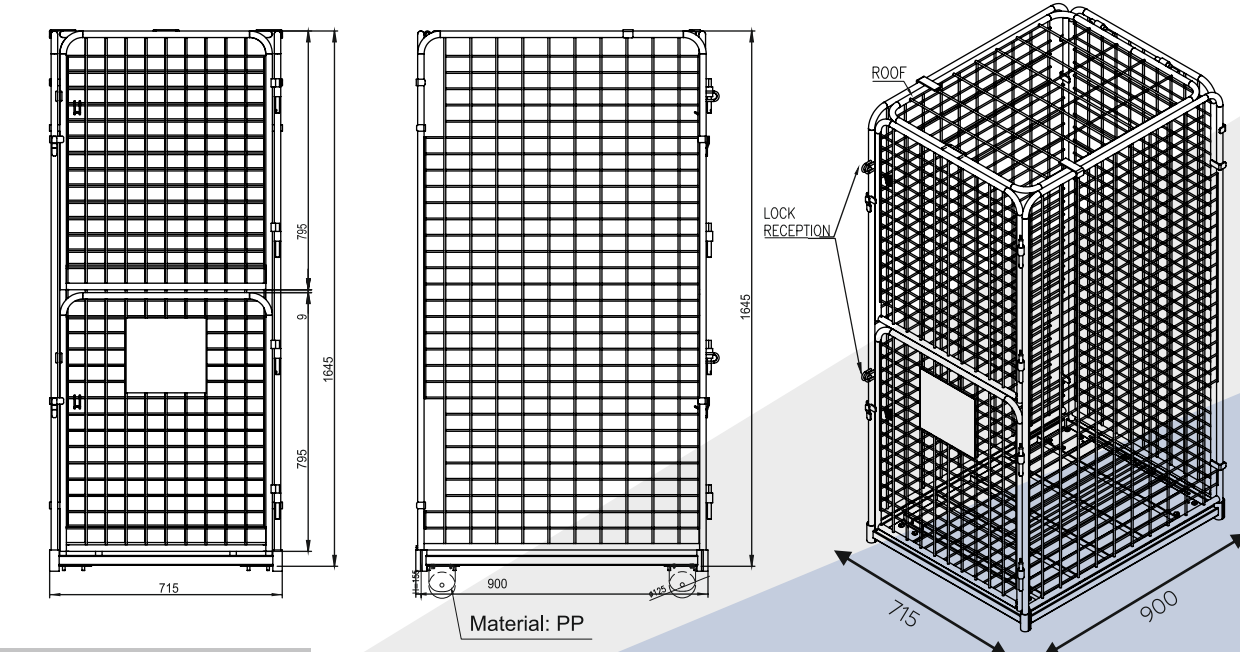

### Technical Features

Product code : RC6\_18 L900 x W715 x H1800mm

Electro-galvanized | Reinforced wire 5mm thick | Wire mesh 50mm x 50mm  
Roof included | Optional shelf | Folding down double door type | 2 fixed castors & 2 swivel with brakes  
Ø125mm diameter (Polypropylene) | Lock reception required | Load capacity : 600kg | Weight : 40kg



## Plastic carrying containers

### Technical Features

Model: trolley 270 External Dimensions: L1040 x W640 x H790mm

Load capacity : 250kg | Weight : 13,5kg

Wheeled

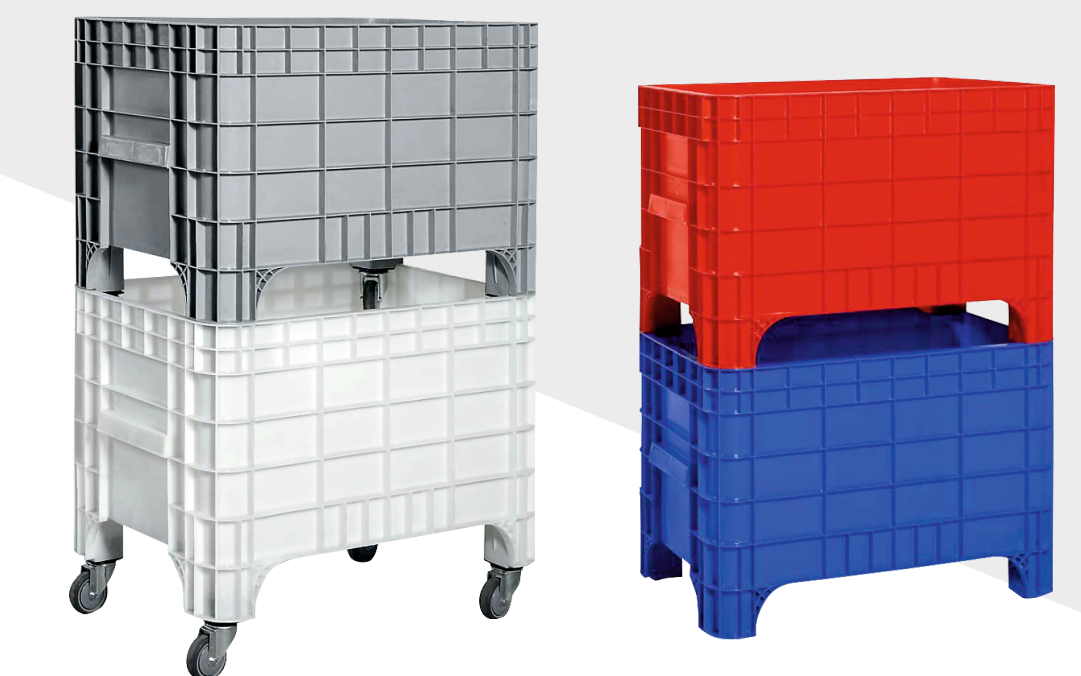
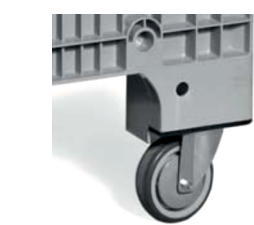

Capacity 270 Lt.

Durable Construction

### Technical Features

Model: trolley 550 External Dimensions: L1200 x W800 x H960mm

Load capacity : 300kg | Weight : 23kg

Optional lid



Capacity 550 Lt.